



2020

***Hengtong
Circular Economy Report***



Contents

Preface: Hengtong and Circular Economy.....	2
I. Hengtong Profile.....	2
II. Hengtong's Goals and Concepts of Green Environmental Protection and Sustainable Development.....	3
Chapter One: Green Factory.....	5
I. Industrial Chain and Its Recyclable Concept	5
II. Reduction, Reuse and Recycle.....	6
1. Green and Smart Workshop.....	6
2. Recycle and Reuse.....	19
3. Green Products.....	26
Chapter Two: Green Partner.....	29
I. Stakeholders	29
II. Partner Management.....	29
III. Social Organizations.....	30
1. Spanish Subsidiary Cablescom joins <i>The Global Compact</i>	30
2. Hengtong Joined Jiangsu Province Renewable Energy Industry Association.....	31
3. Hengtong was recognized as a “Demonstration Enterprise of Circular Economy”.....	32
Chapter Three: Green Action.....	33
I. R&D Investment, Certificate & Qualification.....	33
II. Social Responsibility.....	34
1. The Hengtong Forest.....	34
2. The Paperless Office.....	36
III. Alternative Energy Solutions.....	37
1. Photovoltaic Power Generation.....	37
2. Energy Storage.....	37
3. Wind Power Generation.....	38

Preface

Hengtong and Circular Economy

I. Hengtong Profile

Hengtong Group is engaged in fiber optic optical networks, smart grid, big data Internet of Things, new energy materials and marine communications, energy interconnection and other fields of construction, investment and operation. It has more than 70 wholly-owned and holding companies (including three domestic and overseas listed companies), with industries in many countries all over the world. Its annual revenue has exceeded 100 billion yuan for many years. As the largest system integrator and network service provider in the fields of optical fiber network and smart grid and one of the top 500 enterprises in China, Hengtong has been ranked amongst the world's top three of the most competitive enterprises in optical fiber and cable industry for many years. It has been ranked amidst the world's top four enterprises with the most comprehensive strength in global power industry, and the top five in the field of submarine cable.

[Innovation and Technology]

Hengtong adheres to innovation and creativity to lead the development of the industry. It is an industry leader in terms of industrial standard setting, national patents and international PCT patents. It accounts for 15% of the global market share in the field of optical fiber networks. It is the first Chinese enterprise to deliver more than 10,000 kilometers of submarine optical cables. It is also the first Chinese enterprise whose ultra-high voltage submarine cables entered the international market. Committed to ushering in a new future of Internet of things, Hengtong proactively devotes itself to the new generation IT and energy revolution, new energy and new material, next generation ICT, smart living, and other new areas.

[Global Layout]

"Look at the world map to do business, go international along the Belt and Road." In line with the concept of "extensive consultation, joint contribution and shared benefits", Hengtong continuously promotes its internationalization strategy and has established 11 overseas industrial bases, 2 R&D centers, 9 overseas sales companies and more than 40 sale and service offices in South America, Southeast Asia, South Asia, Europe and Africa. Its business covers more than 150 countries and regions. With high quality and standards,

it has undertaken a large number of system integration and EPC projects, and has made positive contributions to the global connectivity of communication and energy infrastructure by creating jobs, upgrading industrial levels and improving people's livelihood in countries along the Belt and Road.



11
11 Overseas Factories

40+
Sales & Marketing Branches in over 40 Countries

150+
Products and Services Covering more than 150 Countries/regions

[Social Responsibility]

Hengtong is committed to environmental protection and promotes green development with the goal of green factories, green partners and green action. It has the largest green preform production base in the world, and the self-developed new generation of zero-pollution optical fiber material has won the recognition of a green manufacturing project issued by Ministry of Industry and Information Technology of China. It is the second enterprise in the world and the first in China to master this technology. Committed to the sustainable development of humanity, Hengtong has invested in and built a large number of photovoltaic and wind power transmission projects, which provide solutions for carbon and emission reduction and contribute to Hengtong wisdom for containing global warming and tackling climate change.



II. Hengtong's Goals and Concepts for Environmental Protection and Sustainable Development

Hengtong takes environmental protection and sustainable development as one of its corporate social responsibilities, and actively responds to the Millennium Development Goals of the United Nations and *the Paris Agreement*, which aims to contain the increase of global temperature within 1.5 to 2 degrees Celsius in average. Hengtong is committed to creating three milestones, namely Green Factories, Green Partners and Green Actions. We are reducing carbon emissions and harmful substances emissions in the process of production and construction by improving raw materials, innovating technical means, strengthening the control of upstream and downstream links in the industrial chain and supply chain, and carrying out environmental protection initiatives so as to achieve the common goal of maintaining a green plant.

Chapter One The Green Factory

Hengtong is committed to promoting green production and achieving sustainable development goals. It has transformed and upgraded intelligent and automated factories in many of its subsidiaries. According to different production conditions, it has formulated corresponding cleaner production schemes and improved the technical processes, including water circulation systems, green intelligent workshops, intelligent space saving storage, energy scheme optimization, etc. Initiatives have so far saved 7,356 tons coal equivalent per year with an energy consumption per ten thousand yuan output of 0.015 tons coal equivalent.

I. The Industrial Chain and the Circular Economy Concept

(Raw Material Control—Design—Production—Storage—Delivery—After-sales)

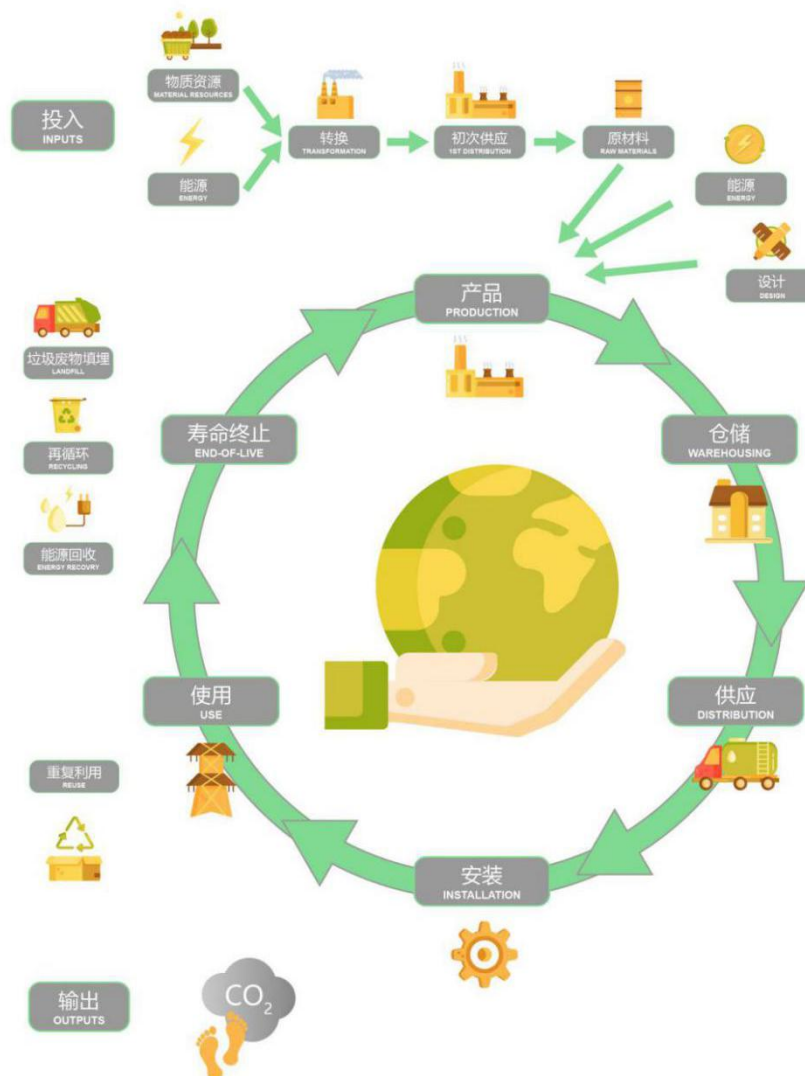

II. Reduction, Reuse and Recycle

1. Green and Smart Workshop

(1) Water Circulation System Improvement

The circulating water system plays an important role in the production of optical cables and power cables, while the cooling of water consumes a large amount of power and produces a large amount of carbon emissions. Hengtong keeps improving the water circulation system to maximise the recycling of cooling water, which saves a great quantity of water and electricity every year and thereby reduces carbon emissions.

Cases:

Subsidiary A: It saves 630,000 KW •H of electricity consumption per year, equivalent to 77.4 tons of standard coal and saves 42,000 tons of water every year;

The first improvement: The small circulation of water in the production line is developed into the large circulation covering the workshop, and the water in the workshop is disposed of in a centralized manner.

The second improvement: The single production line is improved from independent refrigeration to centralized refrigeration by use of a cooling tower.



Centralized disposal of
workshop-used water



Centralized refrigeration
by cooling tower

Subsidiary B: Saves 43,200 KWH of electricity per year and reduces carbon emissions by 11,700 kg/year;

Variable-frequency water supply system: The water supply system used before to circulate cooling water using fixed frequency control. With 30kw of consumption for 24-hour continuous operation, the power consumption was extremely high. To reduce energy consumption, the subsidiary reformed the temperature control system for water circulation, replaced the water tower with new model, designed a variable-frequency water supply system, and optimized the fixed-frequency control system into the variable-frequency control system.



Water cooling tower

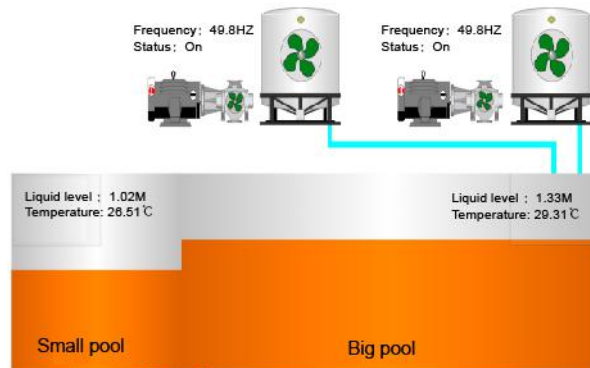

Frequency conversion control system

Subsidiary C: Saves 2.64 million tons of water per year.

The principle of recycling: All cooling water equipment of the company now uses a centralized water supply system, and the cooling water is recycled through the reservoir. An automatic temperature control cooling system is used to keep the circulating water at a constant temperature and ensure the technical and equipment requirements are met whilst reducing overall energy consumption.

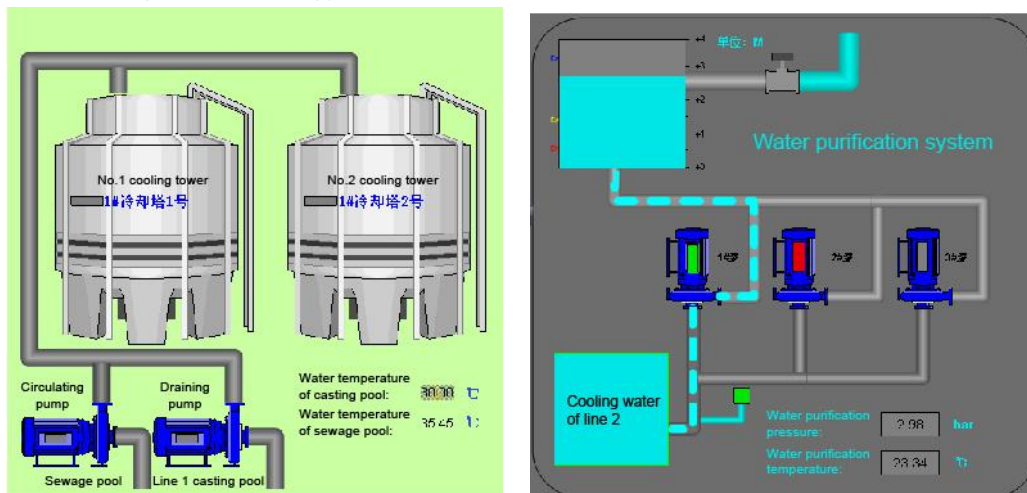

Subsidiary D: The carbon in the water is separated by purifying the water of the casting machine, and the purified water is recycled and reused saving energy and reducing carbon emissions.



purification facilities



automatic dosing devices



carbon removal devices

(2) Electric Forklift

Traditional fuel driven forklifts run on diesel, which generates a lot of carbon emissions. In recent years, Hengtong has introduced electric power forklifts in various subsidiaries to replace fuel driven forklifts, which can significantly reduce the use of diesel each year, and thus reducing carbon dioxide emissions.

Case:

Subsidiary A: Previously the company has 3 diesel forklifts using 27,000 litres of diesel per year (based on the National II Emission Standard). As every litre of diesel saved reduces carbon emissions by 2.63kg, this replacement reduces carbon dioxide emissions by 71.01 tons per year;



Before improvement



After improvement

(3) Improvements in Production Techniques and Equipment

Tens of thousands of kilowatt-hours of energy consumption is saved in the production process per year through improvements in production techniques and equipment.

Cases:

Subsidiary A: Adoption of LED and Ultraviolet Lights for Solidification: Saves 140,000 KWH of energy consumption per year , which is equivalent to 17.2 tons of standard coal;

Integration of Coloring and Coating Procedures: Saves 900,000 KWH of energy consumption per year, which is equivalent to 110.6 tons of standard coal;

Adoption of LED and Ultraviolet Lights for Solidification: A production speed of 2500M/min was reached in the shakedown test, which qualified for the solidification and attenuation detection. The temperature of solidification furnace is reduced by 40°C. Thus the energy consumption of the whole machine is reduced by 61%.



Integration of Coloring and Coating Procedures: The coloring process is integrated into the coating process, reducing air conditioning in the purification workshop generating an overall saving 20% of energy consumption.

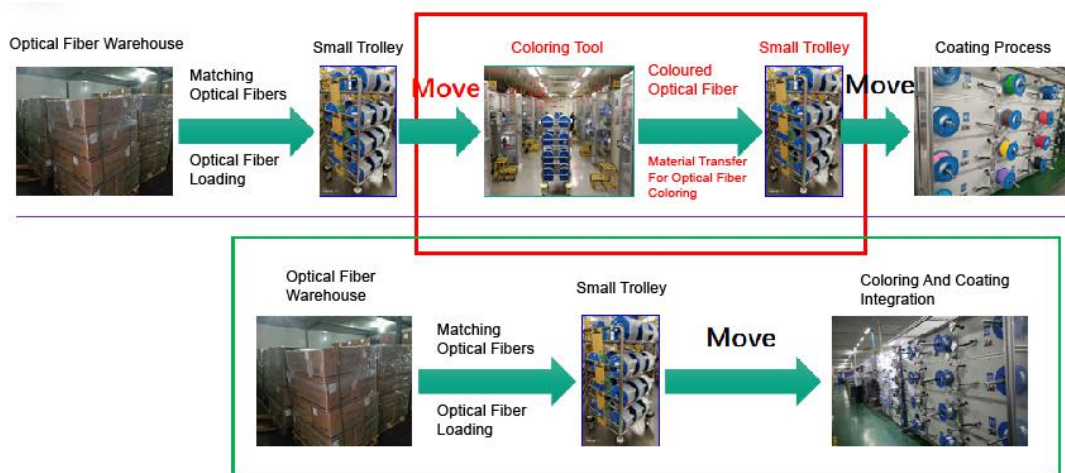

System of Coating Solidification with LED Lights: In order to minimize energy consumption of the coating solidification furnace, the furnace has been upgraded through the construction of an LED coating solidification system. The energy consumption decreased from 1.1 KWH to 0.7 KWH per km, i.e. a 36.4% decrease, and it is also expected to save some 240,500 yuan of annual cost.

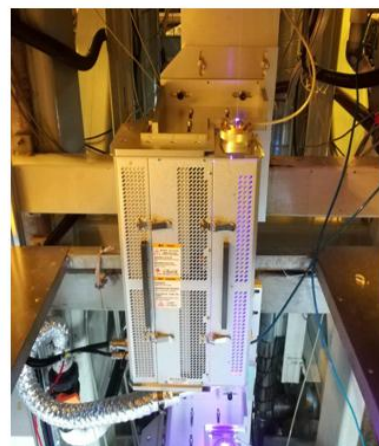

Subsidiary B: Saves 28.89 tons of standard coal equivalent per year through implementing 15 clean production improvement solutions.

东莞市工业和信息化局

东工信函〔2019〕70号

关于公布2018年东莞市清洁生产 企业名单（第二批）的通知

各镇（街）经济科技信息局，松山湖经济贸易发展局，各有关企业：

根据《关于印发〈东莞市“十三五”绿色清洁生产工作推行方案〉的通知》（东府办〔2017〕3号）、《广东省经济和信息化委广东省环境保护厅关于印发清洁生产审核及验收工作流程的通知》（粤经信规字〔2017〕3号）等有关规定，经专家验收、社会公示等流程，现认定宜欣塑胶（东莞）有限公司等138家企业（详见附件）为2018年东莞市清洁生产企业，并将企业名单予以公布，有效期从通过现场验收之日起不超过5年。

上述企业请按照有关规定持续开展清洁生产审核，在有效期届满前，应按有关程序要求开展新一轮清洁生产审核，并申请主管部门的审核验收。有效期届满后未通过审核验收的，东莞市清洁生产企业称号自动取消。

附件：2018年东莞市清洁生产企业名单（第二批）



（联系人：刘杰军，电话：26988212）

The Notice on Announcement of the List of Cleaner Production Enterprises in Dongguan in 2018 (the Second Batch), a document issued by Dongguan Bureau of Industry and Information Technology, Guangdong Province.

The company actively carries out energy conservation and emission reduction activities, paying attention to pollution prevention, reform of materials adoption and technical processes, and updates and transforms equipment to reduce the negative impact on the environment in the production process. It has implemented 15 solutions to improve the production process, making it cleaner, and thus saved 28.89 tons of standard coal per year.

Subsidiary C: Improvement in Flexible Cable Heating System: In order to reduce the power consumption of the factory, this subsidiary started from the major power-consuming equipment and focused on extruders for power consumption control. Based on independent R&D, the extruder's heating system was changed from the traditional cast aluminum heater to the new nano infrared electric heating system, raising the heating efficiency and reducing the energy consumption. The average power consumption was

reduced from 95.09 KWH per 24 hours before the improvement to 60.71 KWH after the improvement, saving 34.38 KWH, a reduction of 30%, and saving 4.19 tons of standard coal per year.



Subsidiary D: Saves 350,000 KWH of energy consumption annually, equivalent to 43.01 tons of standard coal;



It established energy-saving measures by analyzing the electricity consumption, power quality, and electricity analysis, areas of high energy consumption and other aspects of each production line. It reduces energy consumption by 10% through effective energy management.

Subsidiary E: It saves 105,700 KWH of electricity and reduces 11,700 kg of carbon emission per year by introducing an energy-saving variable-frequency air compressor.



Variable-frequency air compressor

Subsidiary F: Improvement in Refrigerator Machine Energy System: In order to reduce the energy consumption of the refrigeration machine to the maximum extent, the machine was upgraded and transformed by improving the energy saving system, after which the energy consumption per fiber-km decreased by 57.1% from 0.21KWH to 0.09KWH.

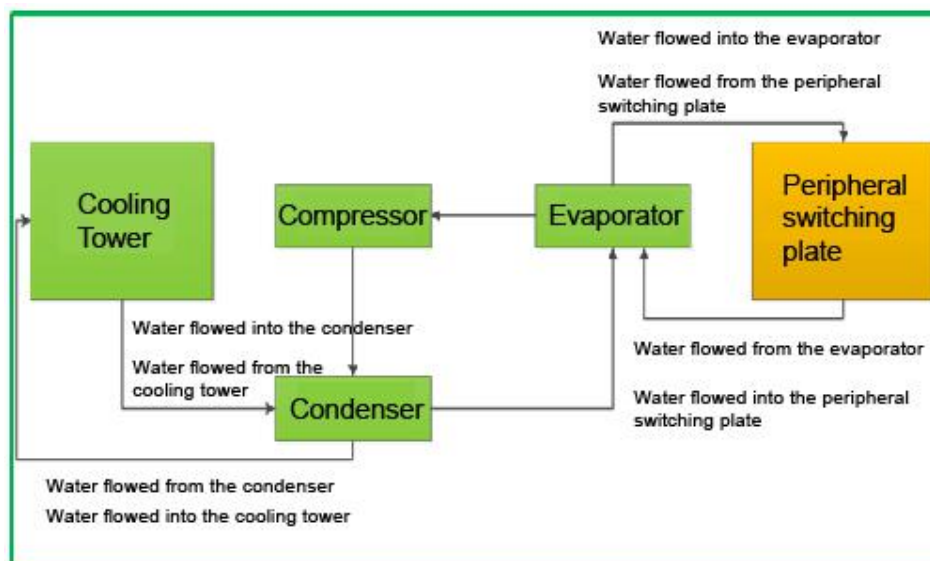

the construction for cooling machine energy saving system

Improvement in the Synthetic Preform Induction Furnace: In order to maximise the reduction in the furnace's energy consumption, the induction furnace was upgraded and transformed with new induction furnace technology, reducing the energy consumption per fiber-km of the induction furnace by 19.2% from 1.3KWH to 1.05KWH.

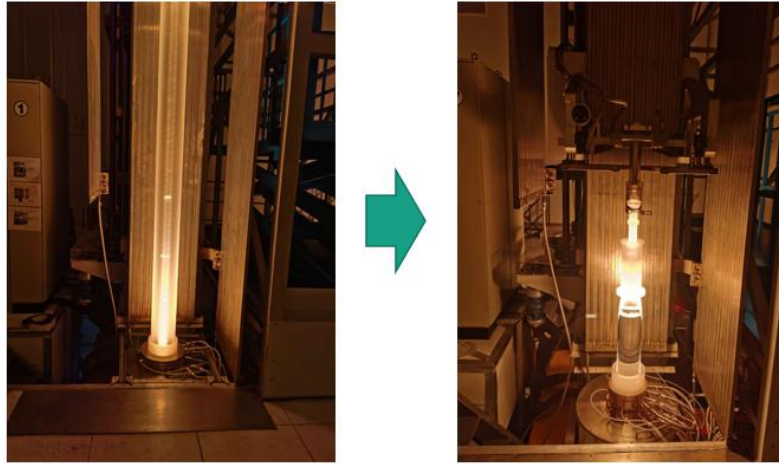

Improvement in synthetic preform induction furnace

Subsidiary G: Adoption of Variable-Frequency Cooling Pump: It saves 108,000KWH per year, equivalent to reducing standard coal consumption by 13.28 tons and carbon emissions by 36.1 tons per year;



Variable-Frequency Cooling Pump

Before the transformation: 2 cooling pumps, each with a fixed frequency of 18KW 45HZ, were used to cool water in each optical cable workshop, operating continuously for 720 hours per month. However, the optical cable production lines were not running at 100%, resulting in inefficient use of the pump.

Improvement measures: Using two variable-frequency cooling pumps of 30KW 45HZ each. These pumps adjust their output power in real time according to the operational requirements of the optical cable production lines, so that more than 98% output power of the pumps are utilized, with electricity useage and carbon emissions reduced.

Adoption of UV LED Lamps: Overall power saving: 96.8KWh/set, power saving per year: 836400KWh, annual reduction in coal equivalent: 102.88 tons, annual reduction in carbon dioxide emissions: 279.8 tons;

Before the changes: It used UV mercury lamps to solidify resin in the drawing machine. The UV mercury lamp consumes significant amounts of power, 153.4KWH in total;

Improvement: UV LED lamps are used to replace the mercury ones. The product quality is good. The power consumption is reduced by 60.8KWH after the improvement.

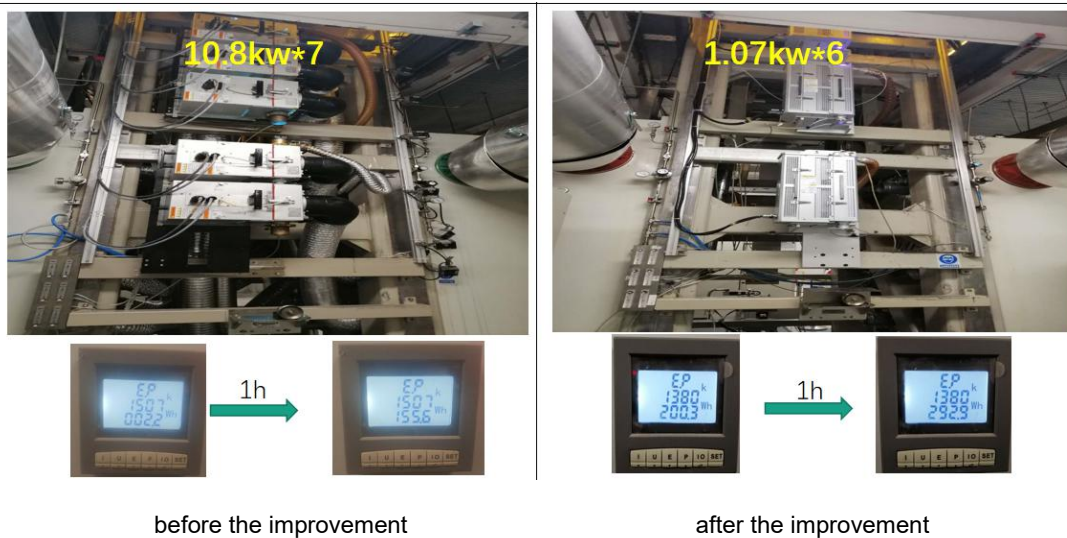

(4) Energy Efficient Lighting

In terms of energy efficient lighting, the more environment-friendly and efficient LED lights are used to replace ordinary lights. The lighting design is optimised according to the actual situation of the factory to avoid waste of electricity.

Cases:

Subsidiary A: The lights in the workshop of the company are all LED lights. The office and plant utilises glass roofs, walls and window, and the production workshop has transparent skylights, which makes full use of natural light.

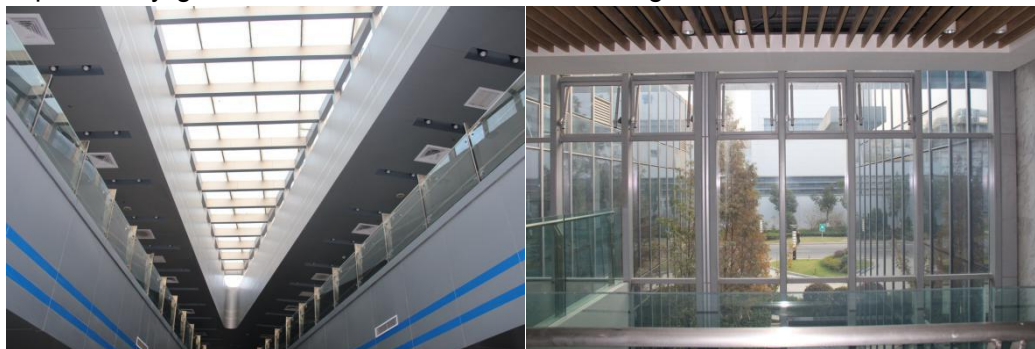

LED lamps and natural light

Subsidiary B: The workshop used ordinary energy efficient lamps up until 2019, which were high in energy consumption and with a short short, and so these lamps were not environmently friendly. These lamps have been replaced with more environment friendly LED lamps. The annual energy saving is about 20,000 KWH, equivalent to 8 tons of standard coal.

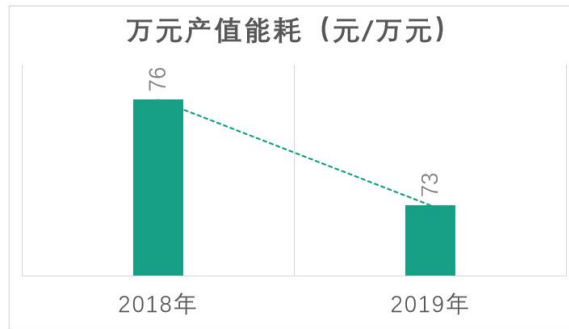

Subsidiary C: Lighting System Energy Saving: In 2019, the annual electricity consumption of the lighting system of the drawing workshop in Area No. 2 was 58,102 KWH; in 2018, it was 80,923 KWH. In comparison, 22,821 KWH was saved in one year, a 28.2% reduction, equivalent to reducing 7.15 tons of coal equivalent and 19.4 tons of carbon emission.

Before the improvement: Normally the lights in the workshops were all-time on, but there may be periods where no operators were using some parts of the workshop. In this case, electricity was being wasted.

Improvement Measures: According to the operation of each area and the inspection route, the company regulated the lighting and established partial lighting in the area without operators.

Switching Table for Lighting of the Drawing Workshop in No. 2 Area								
Floor	Emergency switch	East No.1	East No.2	East No.3	West No.1	West No.2	West No.3	Emergency switch at entrance of elevator
the 2 nd floor	Turn off	Turn on (warm yellow)	Turn on (warm yellow)	Turn on (warm yellow)	Turn off	Turn on	Turn off	
the 3 rd floor	Turn on	Turn off	Turn off	Turn off	Turn off	Turn off		Turn on
the 4 th floor	Turn on	Turn off	Turn off	Turn off	Turn off	Turn off		Turn on
the 5 th floor	Turn on	Turn off	Turn off		Turn off	Turn off	Turn off	Turn on
the 6 th floor	Turn on	Turn off	Turn off		Turn off	Turn off	Turn off	Turn on
the 7 th floor	Turn off	Turn off			Turn off			Turn on

Remark: In the routine inspection process, for the lights do not need to be turned on for a long time should be turned off to save electrical energy.

Subsidiary D: Smart Warehouse Lighting: After adoption, there are a total of 6 sets of control loops covering the whole warehouse. The control method is to install an LCD control panel on the wall of the warehouse office, and set the scene mode, switching time, etc. of each set of lamps through the panel. It saves 59568KWH of electricity consumption per year.

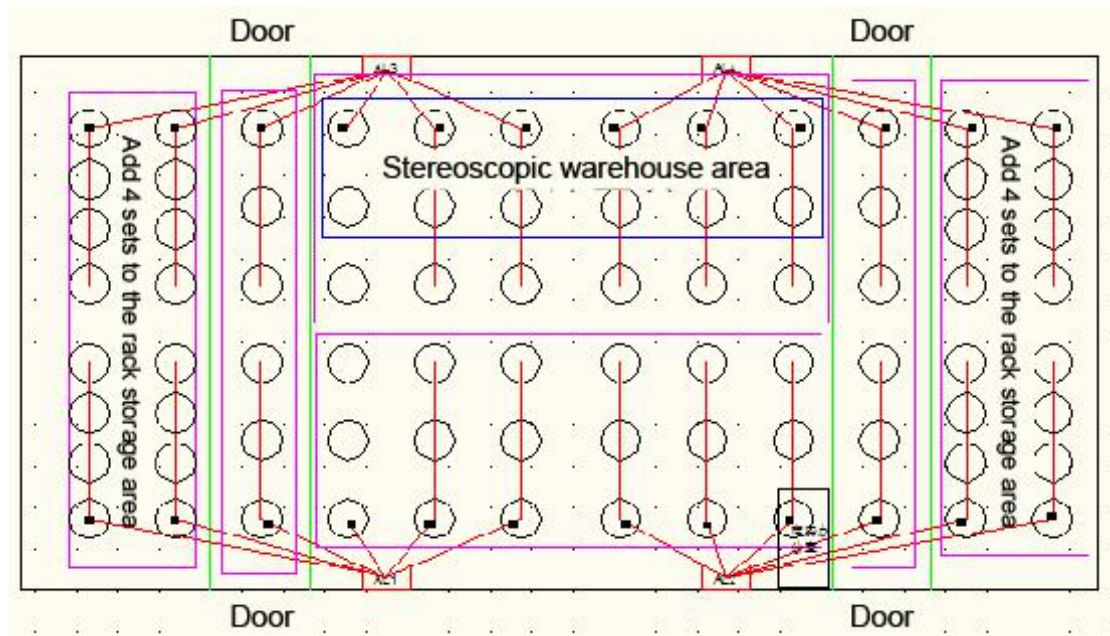

(5) Stereoscopic Warehouse

Cases :

Subsidiary A: Compared with typical warehouses, the space utilization rate of the warehouse was increased by approximately 80% ;



The raw materials and semi-finished products are stored in the stereoscopic warehouse system, which eliminates the need for manual handling, reduces the size of warehouse area and improves efficiency.

Subsidiary B: 630 Stereoscopic Warehouse System



This project was focused on the introduction of stereoscopic storage for the 630 drums used in the drawing workshop. It significantly reduced the large footprint occupied with drum storage, reduced the labor intensity of employees and sped up the automatic circulation process.

(6) Smart Factories

Cases:

Subsidiary A: Through building intelligent and automated green factories, the risk of personal injury has been reduced, and more information is collected; 100% of production line information, public facility information and energy usage information is now automatically collected.



Equipment automation transformation, automatic mechanical winding arrangement, production personnel decreased from 32 to 24.



Information collection systems for production lines, the coverage of information collections of the production lines increased from 0 to 100%.



In order to realize the real-time data collection of electricity consumption by the construction of energy management platform.



Information collection systems for public equipment, the coverage of information collections of the operation of public equipment increased from 0 to 100%.

Subsidiary B: Comprehensively improves the assembly efficiency (more than 30%) by developing automated assembly tubes, which largely saves labor costs and improves product quality (by avoiding product assembly defects);

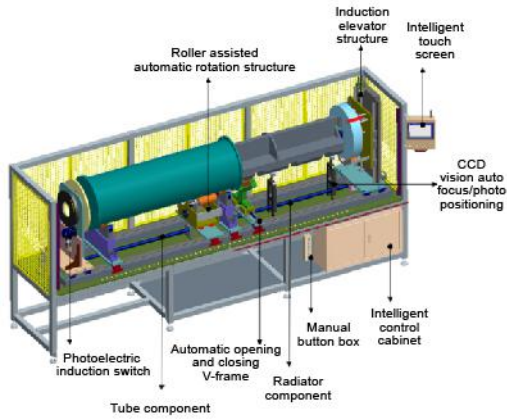

The company has built a new intelligent assembly platform to realize complete automated assembly, which improves the consistency of assembly quality. The intelligent touch screen automatically records the parameters of each assembly scheme to improve the level of unmanned operation, which reduces the work intensity and improves the safety of the whole process.

Subsidiary C: With the paperless office initiative, reduces the use of paper by 54,000 sheets each year.



automatic wiring arrangement device



intelligent machine information terminal system

(7) Exhaust Gas Treatment

Cases:

Subsidiary A: Disposal of Exhausted Gas from Coloring process: Benzene concentration reduced by 85.7%, toluene concentration reduced by 76.4%, xylene concentration reduced by 100%, and total VOCs reduced by 85.3%;

Disposal of Exhausted Gas from Sheathing: xylene concentration of reduced by 91.6%, and total VOCs reduced by 88.6%;

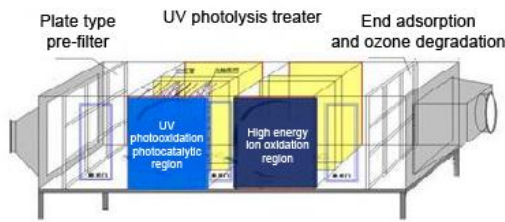

Disposal of waste gas from coloring

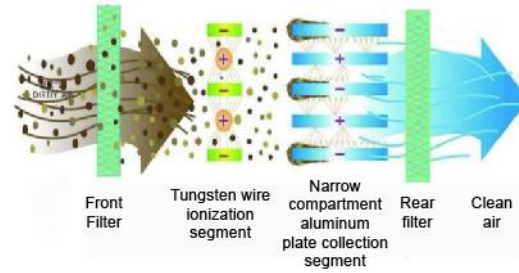

Disposal of waste gas from sheathing

The company completed a review of gas discharges with reference to the emission standard in the local government's *Key Points of Pollution Prevention and Control of Major VOCs Industries*. It concluded that the current gas discharging process from coloring devices may pose a risk of pollutant emission. Therefore, the company introduced UV photolysis equipment to photolyze the gas produced from the coloring machine before releasing it. The company also invites environmental inspection institutions to complete independent emission indicators testing.

In accordance with the guidance of the local Environmental Protection Bureau, the company collects and purifies the waste gas from the sheathing machine, and then uses electrostatic discharge to absorb smoke particles before discharge. It also uses a qualified agency to complete independent emissions testing.

Subsidiary B: Optimizing Asphalt Exhaust Emission treatment

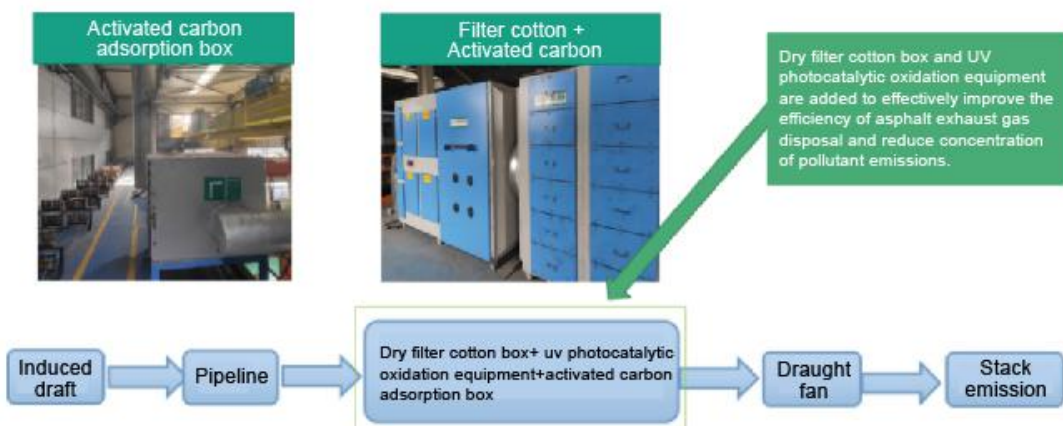

2. Recycle and Reuse

(1) Drums Reuse

These subsidiaries use drums made of multilayer boards which are made of recycled and compressed wood chips. This practice greatly reduces the annual use of new materials and the amount of wood, which results in reducing tree felling.

Cases:

Subsidiary A: It reduces of the consumption of wood by around 180tons saving some 230 adult trees from logging per year.

The improvements: The side plates of the drums are exchanged for multi-layer compressed panels this not only improves the appearance of the side plates of drums, but also reduces the consumption of woods.



Subsidiary B: Saves about 53 KG of woods per drum, which reduces wood consumption by 572.4 tons per year, saving 715 trees per year

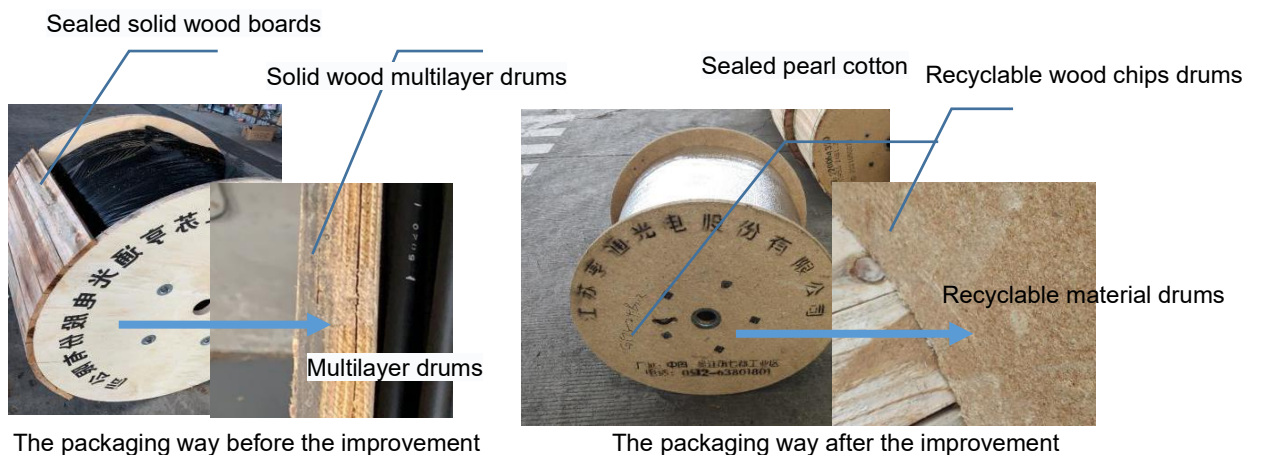

Improvement 1: Using recyclable material molded drums for all packing products, that meet the requirement for packing strength and reduces the consumption of solid wood.

Improvement 2: replacing the solid board sealing with pearl cotton packaging to reduce the consumption of wood for orders that do not need to be stacked high.

Subsidiary C: Reuse: It saves 2,040 plastic pallets per year;



The company uses plastic pallets as the base of packaging for the raw materials and finished products. In order to effectively reduce the consumptions of plastic pallets and improve the utilization of plastic pallets, the company cleans the incoming 1m*1m pallets and reuses them as delivery pallets of finished products.

Subsidiary D: Donates waste drums to local kindergartens to make into tables and stools.



(2) Recycling Waste Material and Exhaust Gas

Cases:

Subsidiary A: Production of each ton of recycled copper can reduce the discharges of 100 tons of industrial waste residues and 2 tons of sulfur dioxides.



It uses old motor and waste wire and cable as the main raw materials in production. The products are copper wire billets. The renewable resources used by the products (waste motor, waste wire and cable) accounted for more than 70% of the material content. Each ton of recycled copper productions can reduce the emissions of about 100 tons of industrial waste residues and 2 tons of sulfur dioxides.

Subsidiary B: The waste recovery rate is 100%, the recycling rate of Helium gas is 70%, and the reuse rate of production water is 99.86%;



Subsidiary C: The average recovery rate of Helium gas reaches 79%, reducing Helium gas emissions by 406.4 to 507.9kg, saving some 300,000 cubic meters gas per jumper and cutting natural gas consumption by 18.5% per year.



After the improvement

Historically, the Helium gas used in the drawing production line was directly discharged into the atmosphere, resulting in air pollution. With the improvement, a Helium recovery device was added to collect the used Helium gas for reuse, reducing the amount

of Helium directly emitted into the atmosphere.

Subsidiary D: It saves about 300,000 cubic meters of gas per year for each line;

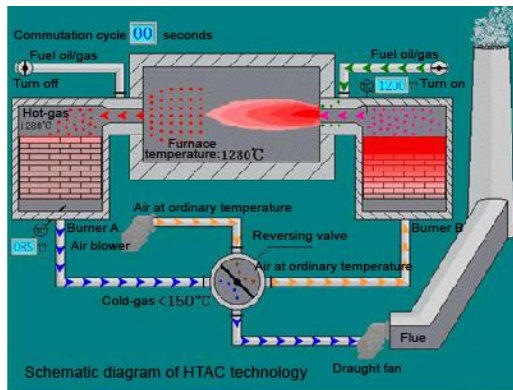

In order to realize the use of waste gas to preheat the air, each burner is equipped with a burner nozzle, each burner nozzle is equipped with a regenerative bed with alumina ball as the heat storage medium, two burner nozzles combust alternately, and the two regenerative beds store up heat in turn. This technique avoids energy waste the caused by direct emission of hot exhaust gases.

Subsidiary E: Increases the concentration of passivation liquids and secondary use. Through doing this, the annual consumption of passivation liquids is reduced by 50%;



危险废弃物委托处置协议

委托方:【江苏亨盛环保科技有限公司】(以下简称“甲方”)
 受托方:【江苏亨盛环保科技有限公司】(以下简称“乙方”)
 协议地址:【苏州工业园区】
 法定代表人:【】
 联系电话:【0512-83802113】

依据《中华人民共和国环境保护法》、《中华人民共和国固体废物污染环境防治法》及其
 他相关法律法规的规定,甲乙双方友好协商,一致,就危险废物委托处置事宜达成
 如下协议:

第一条 委托处置危险废物的种类及价格

序号	危险废物名称	废物代码	计量单位	含税单价	税率	预计量
1	废转化液	336-064-17	吨	3500	13%	8
2	废抹布	900-041-49	吨	5000	13%	0.8
3	废活性炭	900-041-49	吨	8000	13%	0.6
4	废活性炭	900-041-49	吨	2800	13%	0.2
5	废活性炭	900-041-49	吨	4500	13%	3
6	废活性炭	900-041-49	吨	5000	13%	2
7	废活性炭	900-236-12	吨	5000	13%	0.4
8	废活性炭		吨	5000	13%	3

注:(1)以上单价为含税价,已包含废物包装、装车、装卸费,依据每年甲方
 委托的全部费用;
 (2)协议期内本协议有效期内,甲方在正常生产情况下可能会产生的危险废物,具体
 的数量和种类每年另行协商。

第二条 协议有效期
 本协议有效期为【2020】年【01】月【01】日起至【2020】年【12】月【31】日止,
 在本协议有效期内,乙方有义务按照本协议规定的条件和价格处理甲方生产过程中产生

**Operating Permit for Hazardous Waste
 Agreement for Entrusted Disposal of Hazardous Waste**

In order to increase cable ductility, the passivation liquids need to be used in the production process of through-railway ground wire. The company commissions a qualified professional enterprise to process the waste passivation solutions. It exposes the used passivation liquids to sun light. The water within the passivation liquids is evaporated, and oil-water separation is realized. The concentration of the passivation liquids is thus increased and it can then be reused. It has been verified that the scheme is feasible as it has no negative effect on the quality of product.

Subsidiary F: The consumption of natural gas reduced by 18.5% after improvement;



on-line monitor



heat exchanger

combustor

Improvement measures: Through the introduction of RTO heat storage organic exhaust gas oxidation treatment equipment, we achieved the purpose of heat energy recovery, in line with exhaust gas emission standards.

Subsidiary G: Improvements to the sampling technique saves 250 kg of materials per month, with an average of 150.22 kg of tricobalt tetraoxide dedusting materials recycled per month;



In order to ensure the product quality in the production process, the company samples the intermediate materials and finished materials and conducts physical and chemical performance analysis, in which process sampling bags are used. Since the sampling amount normally exceeds actual amounts needs for the tests, the remaining test materials are classified and stored according to the product type and process , and are regularly recycled to each process or warehouse of production. It reduces wastes, reduces cost, and improves material utilization rate, saving 250 kg of materials per month.



The first step in the preparation process of producing lithium ion cathode material of the company is to feed the raw material after opening the bag. Since the raw material tricobalt tetraoxide is a powder, dust will be generated in the feeding process. In order to effectively reduce the dust pollution in environment and improve the utilization rate of raw materials, the tricobalt tetraoxide dust in the feeding process is collected through the customized high-performance dust remover. Then the collected normal raw materials are returned to the production process through the magnetic test for raw material screening.

Subsidiary H: The reuse rate of industrial water is 87.86%, and the recycling rate of cooling water is 97%.



Disposal for high temperature waste gas

3. Green Products

(1) Improvement in Raw Materials



Silicon tetrachloride is used in the production process of preforms, which produces hydrogen chloride gas that can pollute the environment. In order to protect the environment, Hengtong independently developed the green preforms, using organic silicon, a kind of green and efficient material to replace the high pollution material. It is the first company in China and the second company in the world to master this independent intellectual property, which has been recognized as one of the Green Intelligent Manufacturing Projects of China.

Cases:

Subsidiary A: Reduced hydrogen chloride emissions by 18,000 tons , 860,000 cubic meters of rare gas imports, 100 million KWH line loss, 36,000 tons coal consumption, and 420,000 tons carbon dioxide emissions per year.

Hengtong has the largest single manufacturing base of green optical fiber.

Organic silicon is used to replace SiCl_4 as a new generation raw material for optical fiber preforms production, which has the characteristics of green sourcing, harmless process and clean discharge.

 <p>Silicon tetrachloride</p>	 <p>Octamethyl cyclotetrasiloxane</p>
Chemical formula: SiCl ₄	Chemical formula: (CH ₃) ₈ O ₄ Si ₄
分子量: 170	Molecular weight: 297
Toxicity: highly toxic	Toxicity: non-toxic
Corrosivity: strong corrosion	Corrosivity: noncorrosive
Silicon content: 17%, low	Silicon content: 38%, high
High pollution: 40,000 tons of hci are produced per year	No pollution: the content of chlorine contaminant is 0
VS	
$SiCl_4 + 2H_2O \rightarrow SiO_2 + 4HCl$	$C_8H_{24}O_4Si_4 + 16O_2 \rightarrow 4SiO_2 + 8CO_2 + 12H_2O$

Subsidiary B: The company introduced the concepts of ecological design and environmental protection factors into product design, taking into consideration the environmental impact of the whole life cycle of product in the design stage, and minimizes the negative impact of products on the environment through improvement of the design;



Test Report



Certification for High-Tech Product



Subsidiary C: Lightening the load of High-Voltage Wiring Harness; Integrated On-Board Car Charger Products.



Battery cable is the main component of electric power transmission in automobiles.

The traditional design uses copper as a conductor, which is expensive and heavy. At present, the subsidiary is working on the R&D of aluminum conductor power cable products. It would not only achieve energy saving and emission reductions, but also improve the range and other capabilities of pure electric or hybrid electric vehicles.

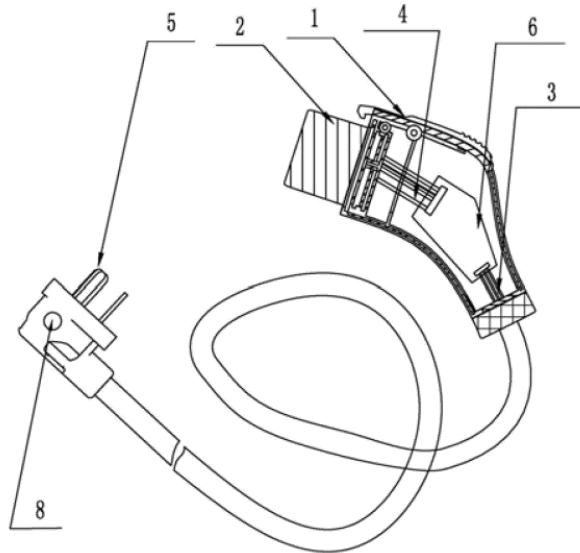

Combine the charger head and control box into one

The triangle plug: 1.5*3 PVC

Length: 5.3m

The charging gun head and the car charge control box are synthesized into one:

The on-board charger control box shell and charger shell are integrated to decrease the development cost of the control box mold and the control box parts;

The control box structure is no longer used, the seat for control box assembly are removed, and so labor hours are reduced;

Because of the removal of the control box housing, the risk of leakage of part of the control box reduces the risk of failure with vehicle charge protection.

Chapter Two Green Partners

I. Stakeholders

Internal training: Education, trainings and competitions to test knowledge related to green energy saving and environmental protection are held every year/quarter;

External communication: Actively participating in exchanges with external entities and training related to environmental protection to access the latest policy related information.



“亨通杯”节能知识竞赛

6月14日

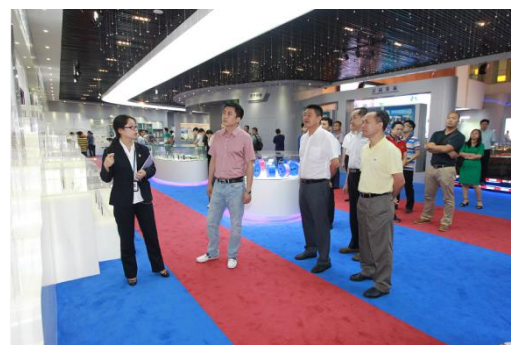

II. Partner Management

Suppliers are required to commit to innocuous, clean, low carbon production processes and recycling;

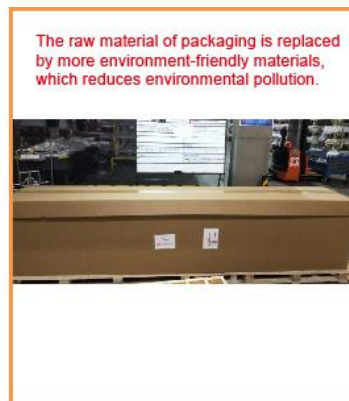

Suppliers are required to have environmental safety certificates.

Company A: Suppliers are required to submit a certified copy of ISO 14001 at the time of purchase;

Company B: Suppliers should be in compliance with ISO 14001 certification standards.

III. Social Organizations

1.Spanish Subsidiary Cablescom joins *The Global Compact*

10 principles of *The Global Compact*

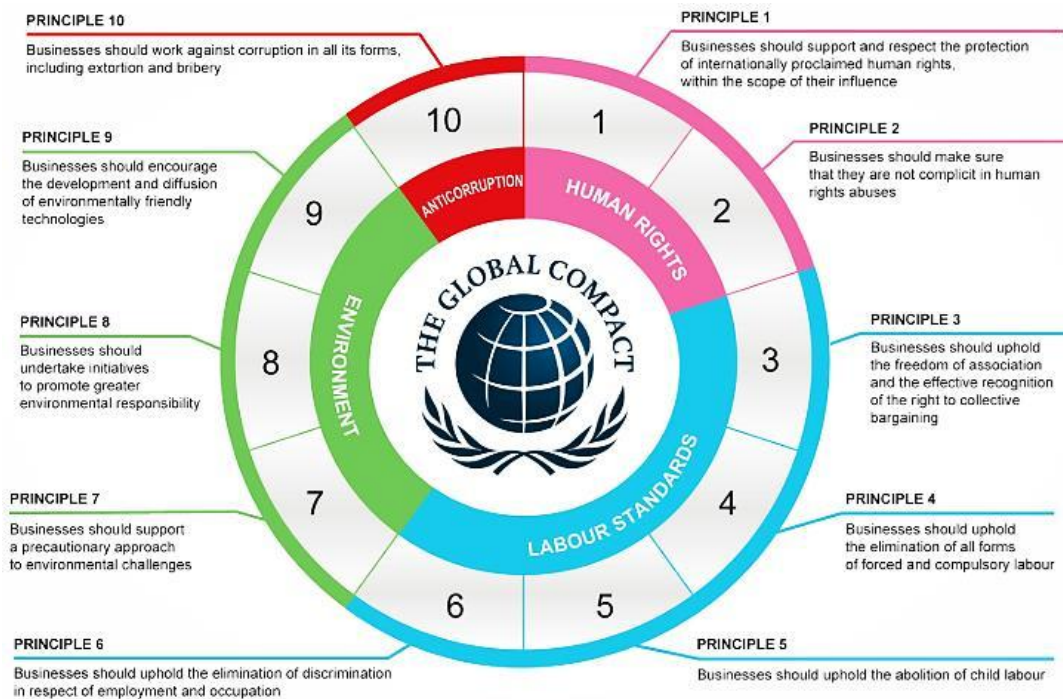

Cablescom is committed to all Sustainable Development Goals



(1) Poverty eradication: Cablescom is committed to hiring people living below the poverty line, and ensuring adequate wages and working conditions for particularly vulnerable groups.

(2) Zero hunger: Cablescom holds activities to reduce waste in the company canteen, makes food plans for staff, and conducts food collection activities in collaboration with the Zaragoza Food Bank.

(3) Health and well-being: Cablescom invests heavily in preventive measures to improve working conditions, promote corporate healthcare and restore pharmaceutical services in Cablescom. It participates in the Por ti program developed by Quirón Salud and Fundación Ibercaja to promote healthy living habits (with emphasis on family, physical health and healthy eating) inside and outside the company.

(4) Gender equality: Cablescom upholds gender equality policies employing women in all positions, especially in the production process. It always promotes gender equality within the company.

In May 2020, Cablescom was awarded signatory status for its outstanding commitment to the 10 Principles and 17 Sustainable Development Goals.

2. Hengtong Joined Jiangsu Province Renewable Energy Industry Association



3. Hengtong was recognized by Suzhou Municipal Government as a “Demonstration Enterprise of Circular Economy” (2012)

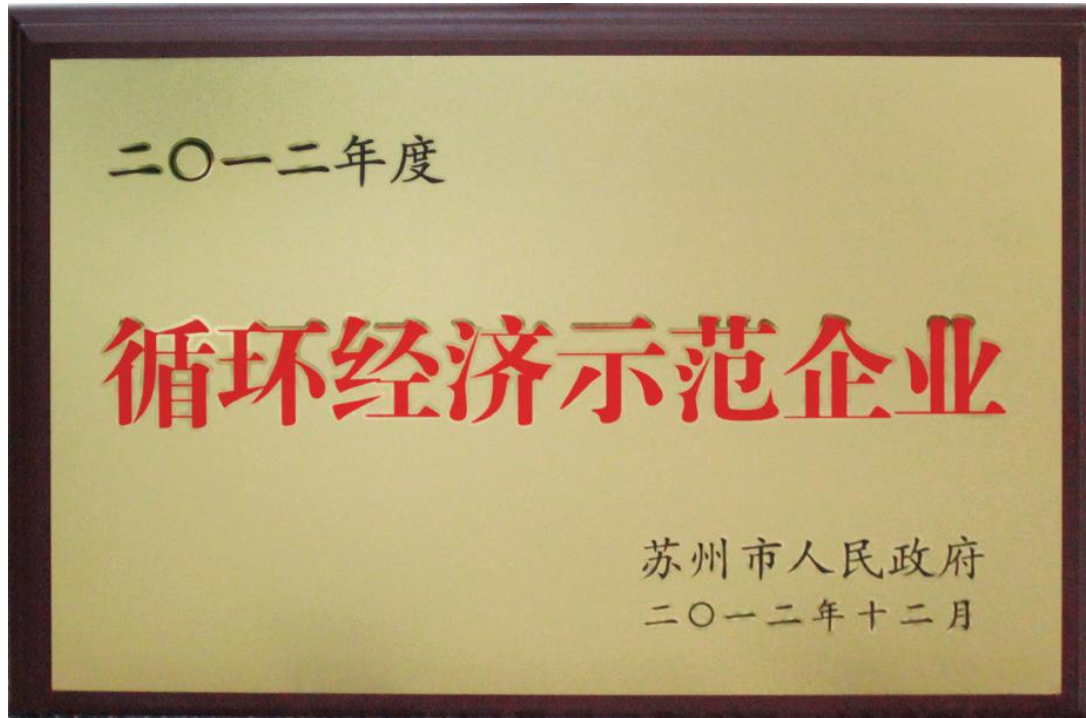

Chapter Three

Green Action

I. R&D Investment, Certificate & Qualification

Hengtong Group was awarded China Energy Efficiency Star (Five-Star Unit) by the National Energy Conservation Center. Hengtong Optical Material, Hengtong Optic-Electric, Hengtong High Voltage, Tianjin MGL, Xi'an-Furukawa Optical Communication, Zhejiang Dongtong were selected as national Green Factories; Tianjin MGL was awarded the 2020 National Green Supply Chain; Hengtong Power Cable, Jiangsu Alpha Optic-Electric Technology and Shenyang Hengtong were selected as provincial Green Factories.

The company starts to consider energy saving during product development, structure design and raw material selection. The products developed have been evaluated successively:

2012-2013 China Communication Industry Energy Saving Technology Innovation Award (Ultrafine Air-Blowing Micro Optical Cable);

Global Examples of Green Technologies (products) for Human Settlements;

Made in China 2025- Green Manufacturing System Integration Project;

In the Ministry of Industry and Information Technology's fifth issue of the green manufacturing list, Hengtong has three products on the list, which are flame retardant ribbon optical cable for subways, digital communication cable and flame retardant flexible cable for communication cable.

Other honors are as follows:

1. Hengtong High Voltage:

The company established the environmental management system in 2012, and obtained the environmental management system certification issued by the China Quality Certification Center;

In 2018, it was recognised as a national "Green Factory".

In 2019, it successfully passed an audit by ENEL (Italy);

In May 2020, it passed the three in one systems certification of CQC China Quality Certification Center, the version changed from OHSAS18001 to ISO45001;

In 2020, it was awarded "Advanced Collective for Environmental Protection" and "Advanced Collective for Energy Conservation and Circular Economy" by Changshu Economic and Technological Development Zone.



(Honors, Environmental Management System Certification, Quality Management System Certification)

2.Hengtong Optical Material:

"Green Manufacturing System Integration Project" of Ministry of Industry and Information Technology in 2016;

"Intelligent Manufacturing New Mode Application Project" of the Ministry of Industry and Information Technology in 2017.

In 2017, won the title of "Intelligent Demonstration Workshop" of Jiangsu Province.

In 2018, participated in the establishment of green factory standards in the communication industry;

In 2019, "Environment-friendly Green Preform Industrialization Project" won the Suzhou Science and Technology Development Plan;

In 2019, it was awarded Jiangsu Engineering Technology Research Center.

3.Jiangsu Alpha Optic-Electric Technology:

In 2019, was awarded Suzhou Intelligent Demonstration Factory;

In 2019, the company was awarded the "One-train Process of Technique" project by the Ministry of Industry and Information Technology.

4.CABLESCOM:

Won UNE-EN-ISO 9001 and 14001 certification;

II.Social Responsibility

1.The Hengtong Forest

Tree planting and garbage collection activities are held every year to encourage companies to plant trees and build garden-style factories.

Cases:

Company A: The total number of planted trees is 59. According to the annual carbon

absorption of 10 kg per tree, the annual carbon reduction is 2,090 kg.



Company B: March 12 Arbor Day Tree Planting Activity, Yushan Public Welfare Garbage Pick Activity, "Green, Clean and Beautiful" Cleaning Activity in Park;



Company C: Green environmental protection activities will be held for four consecutive years with the themes of "publicizing environmental protection concept and advocating green life", "environmental protection tour around Taihu Lake", "creating green fashion, embracing green life" and "environmental protection practice, starting from me", and employees will be organized to clean up waste in grass and woods along Taihu Lake.



Publicize the concept of environmental protection and advocate green life

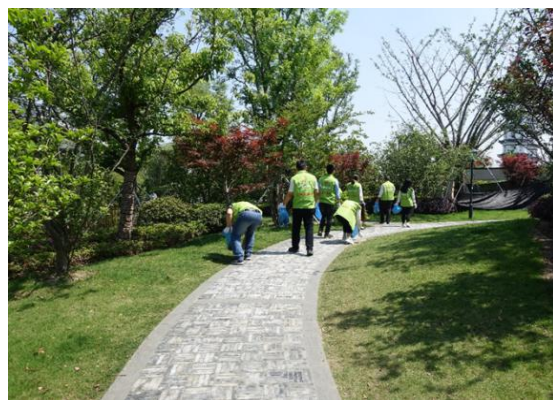

Environmental protection tour around Taihu Lake

III. Alternative Energy Solutions

1. Photovoltaic Power Generation

Solar energy utilization (complementary fishing-light) : contracted to provide a 15MW fishing-light complementary photovoltaic power generation project covering an area of about 300 mu in Ledong, Hainan, with an average annual power generation of 18.420,500 KWH. Compared with the thermal power plant with the same amount of electricity, it can replace about 7368.18 tons of standard coal, reduce about 18,365.20 tons of CO2 emissions, 552.61 tons of SO2 emissions, 276.3 tons of nitrogen compounds, and 5010.36 tons of carbon dust emissions every year.



site drawing after completion

2. Energy Storage

The bus terminal charging projects of Mingzhu Community of Wujiang city in 2017, a total of 10 units of 100 kw dc charging, provided the charging services for 40 new energy buses, with an average of 6000 KWH/day of charge capacity , saved 1244487 litres of oil for the country, using breakthrough technologies such as plug without electricity, flexible charging, active defense , and the carbon emissions reduction was 2067923 kg.



Photovoltaic-Storage-Charging integration project: "Photovoltaic-Storage-Charging" integration of electric vehicle charging station integrated multiple technologies such as photovoltaic power generation, large capacity storage battery charging, intelligent charging units, it saves 50000k Wh of Grid power purchasing within 1 year, the energy storage system enabled peak load shifting and the distribution of capacity cost saving, increases the consumption of new energy. The new energy vehicles saves a 77794.53 liter by using intelligent charging, the reduction of carbon emissions reached 129268.58 kg.



3. Wind Power Generation

Guangdong Yudian Zhanjiang Wailuo Offshore Wind Power Project: Zhanjiang Wailuo Offshore Wind Power Project is located in Xinliao Island, Xuwen County, Zhanjiang City, Guangdong Province and the offshore area to the east of Wailuo. The total installed capacity is 198MW, including 36 Mingyang 5.5MW wind power units. Every year, about 170,000 tons of coal can be saved, and about 350,000 tons of carbon dioxide and 280 tons of sulfur dioxide can be reduced, which play a positive role in promoting energy conservation and emission reduction as well as optimizing and adjusting the energy mix.



Hebei Laoting Bodhi Island Offshore Wind Power Project: The 30MW Hebei Laoting Bodhi Island Offshore Wind Power Project is the first offshore wind power project under construction in northern China and the first approved offshore wind power project in the Bohai Sea. Compared with the thermal power project with the same generating capacity, the project can save about 244,000 tons of standard coal, reduce sulfur dioxide emission by 4,202.47 tons, reduce carbon monoxide emission by 56.9 tons, reduce carbon dioxide emission by 625,700 tons, and save water by 225,000 tons every year.



Portugal Offshore Wind Power Project: In April of 2018, Hengtong successfully won the contract for the Windfloat Atlantic Export Cable System EPC&M Project in Portugal. As the world's first commercial semi-submersible offshore wind power project, Windfloat Atlantic was developed by European companies such as EDPR, ENGIE, PRINCIPLE POWER to supply power onshore through offshore wind power. The first phase of the project has three turbines with a total installed capacity of 25 megawatts, located in the Atlantic Ocean about 18km from the northern city of Viana do Castelo and scheduled to run for 25 years. Hengtong won the bid with the EPC+M model, and made use of high-end Marine cable engineering technology to integrate global resources and provide integrated solutions. Hengtong, together with teams from Britain, Portugal and other countries, created a number of new technological breakthroughs.

The project contributes to the development of marine resources, the development of clean energy and the achievement of energy self-sufficiency in Portugal. After completion of the project, it will meet the electricity needs of 60,000 European homes

each year. It is predicted that Portugal could meet all of its electricity needs from renewable sources by 2050. Hengtong will add a bright color to this green future and contribute to the sustainable development of mankind.





亨通集团



HENG TONG

Add: No.2288 Zhongshan North Road,Wujiang District,Suzhou,Jiangsu Province,China

Postcode: 215200

Tel: +86-512-6395 7850

Fax: +86-512-6395 7922

Website: www.hengtonggroup.com/en

Email: info@hengtonggroup.com